

Tadiran Lithium Batteries

PulsesPlus
Batteries



- ▶ High energy
- ▶ Up to 3 A pulse capability
- ▶ Instant voltage response
- ▶ No passivation effect



Type: TLP-91111/A

Performance Data

(Typical values for batteries stored at 25°C for one year)

System	LTC and HLC
Nominal voltage	3.6 V
Nominal capacity	2.4 Ah
Nominal current	2 mA
Max. 1 s pulse to 3 V	3 A
Max. pulse length @ 0.5 A	1000 s
Delay time to 3 V @ 0.5 A	none
Weight	55 g
Temperature range	-40°C ... +85°C
Capacity retention after 10 yr	87%

The battery is designed for applications where low background currents are combined with high current pulses. The **PulsesPlus** battery combines the inherent benefits of bobbin type Lithium Thionyl Chloride (LTC) batteries with a novel hermetically sealed hybrid Layer Capacitor (HLC). The LTC battery contributes high energy density while the HLC contributes high pulse current capability. The overall self discharge is thus minimized while safety is maximized.

Voltage during a Pulse at +25°C

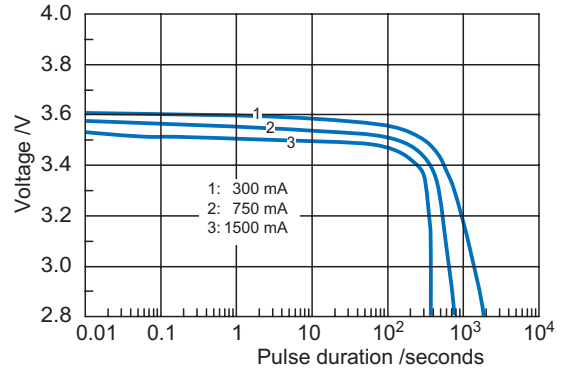

Maximum Pulse Width from 3.6 V to 2.8 V

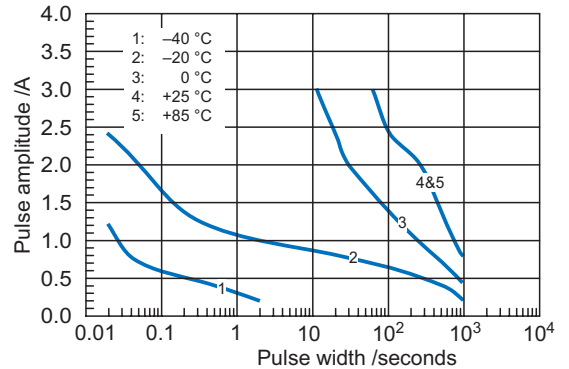

Pulse Voltage after 1 s

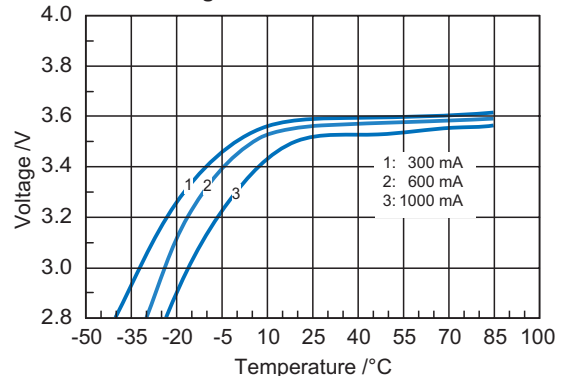

Available Capacity

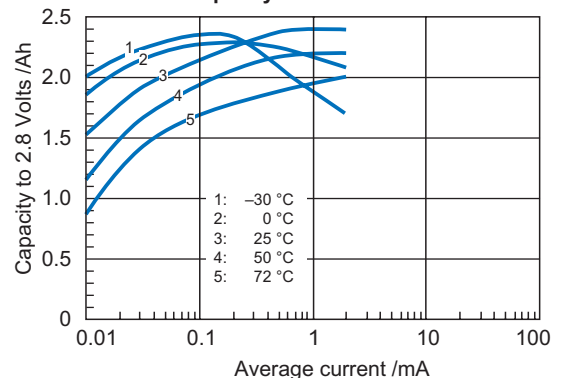

TLP-91111/A/SM

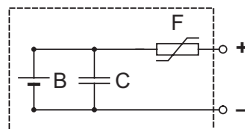
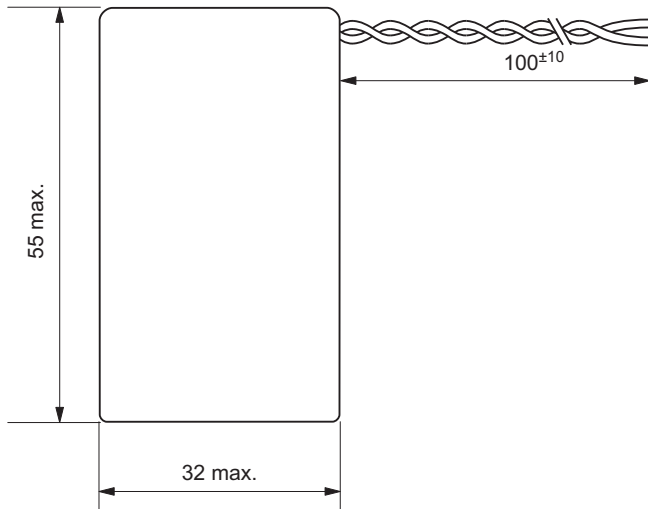

B = LTC battery
C = HLC
F = PTC (optional)

Both the LTC battery and the HLC are UL recognized.

Any values given here are for informational purpose only. They also depend on actual conditions of use and are not warranties of future performance. Subject to change.

Available Terminations

TLP-91111/A/SM Flying leads

Catalogue No.

14 1 5761 001



- ▶ High energy
- ▶ Up to 1 A pulse capability
- ▶ Instant voltage response
- ▶ No passivation effect

Type: TLP-91311/A

Performance Data

(Typical values for batteries stored at 25 °C for one year)

System	LTC and HLC
Nominal voltage	3.6 V
Nominal capacity	2.4 Ah
Nominal current	2 mA
Max. 1 s pulse to 3 V	1 A
Max. pulse length @ 0.125 A	1000 s
Delay time to 3 V @ 0.125 A	none
Weight	40 g
Temperature range	-40 °C ... +85 °C
Capacity retention after 10 yr	90 %

The battery is designed for applications where low background currents are combined with high current pulses. The **PulsesPlus** battery combines the inherent benefits of bobbin type Lithium Thionyl Chloride (LTC) batteries with a novel hermetically sealed hybrid Layer Capacitor (HLC). The LTC battery contributes high energy density while the HLC contributes high pulse current capability. The overall self discharge is thus minimized while safety is maximized.

Voltage during a Pulse at +25 °C

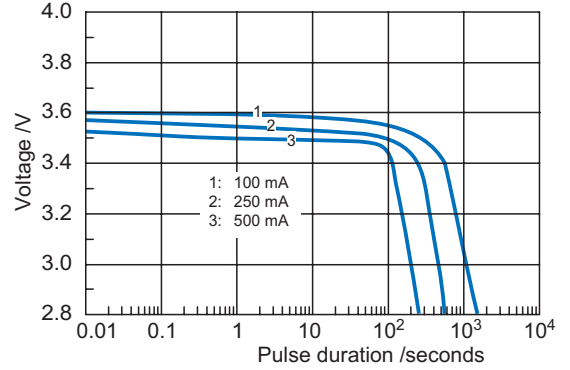

Maximum Pulse Width from 3.6 V to 2.8 V

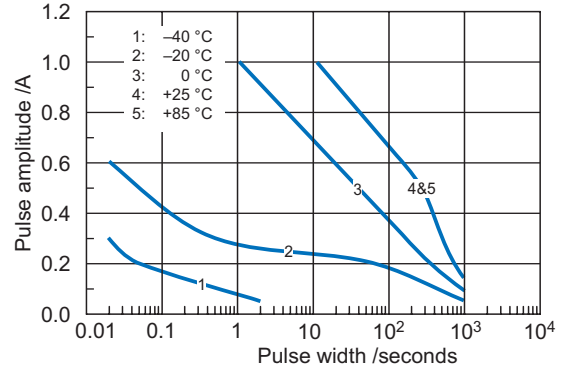

Pulse Voltage after 1 s

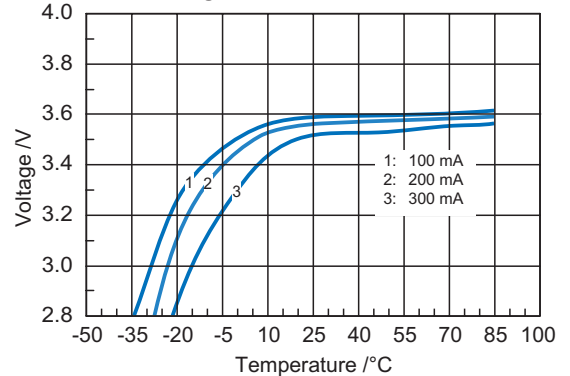

Available Capacity

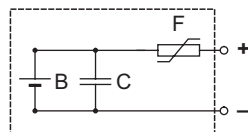
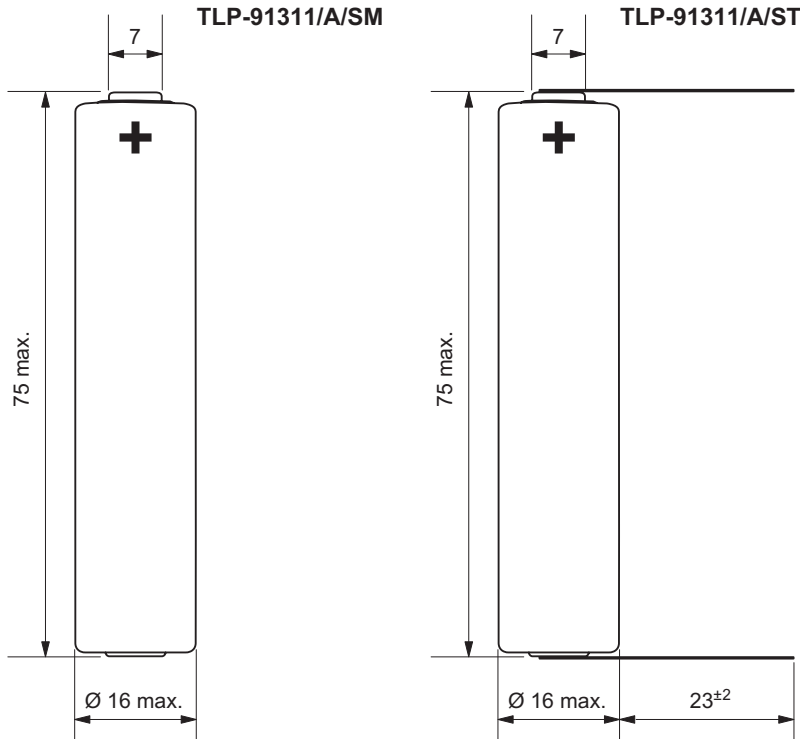
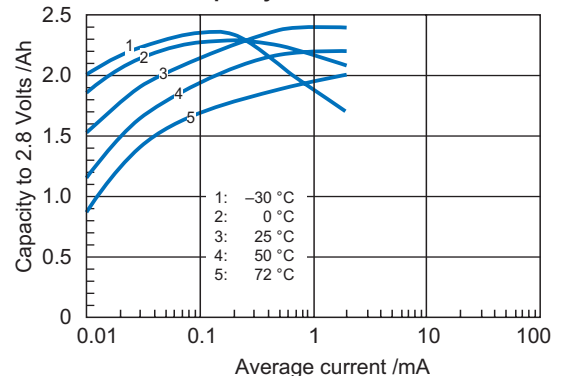

B = LTC battery
 C = HLC
 F = PTC (optional)

Both the LTC battery and the HLC are UL recognized.

Any values given here are for informational purpose only. They also depend on actual conditions of use and are not warranties of future performance. Subject to change.

Available Terminations

Catalogue No.

TLP-91311/A/SM	Pressure contacts	14 1 5763 001
TLP-91311/A/ST	Solder tags	14 1 5763 002

- ▶ High energy
- ▶ Up to 3 A pulse capability
- ▶ Instant voltage response
- ▶ No passivation effect



Type: TLP-92111/A

Performance Data

(Typical values for batteries stored at 25°C for one year)

System	LTC and HLC
Nominal voltage	3.6 V
Nominal capacity	8.5 Ah
Nominal current	3 mA
Max. 1 s pulse to 3 V	3 A
Max. pulse length @ 0.5 A	1000 s
Delay time to 3 V @ 0.5 A	none
Weight	100 g
Temperature range	-40°C ... +85°C
Capacity retention after 10 yr	93%

The battery is designed for applications where low background currents are combined with high current pulses. The **PulsesPlus** battery combines the inherent benefits of bobbin type Lithium Thionyl Chloride (LTC) batteries with a novel hermetically sealed hybrid Layer Capacitor (HLC). The LTC battery contributes high energy density while the HLC contributes high pulse current capability. The overall self discharge is thus minimized while safety is maximized.

Voltage during a Pulse at +25°C

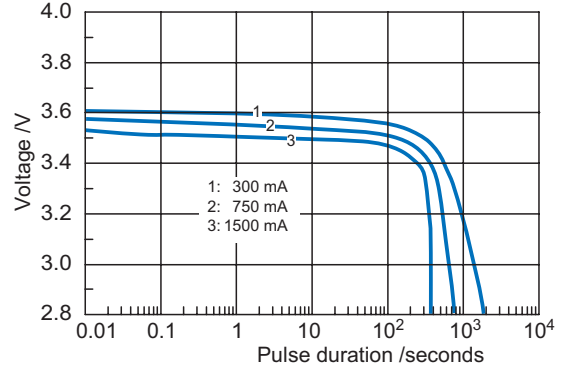

Maximum Pulse Width from 3.6 V to 2.8 V

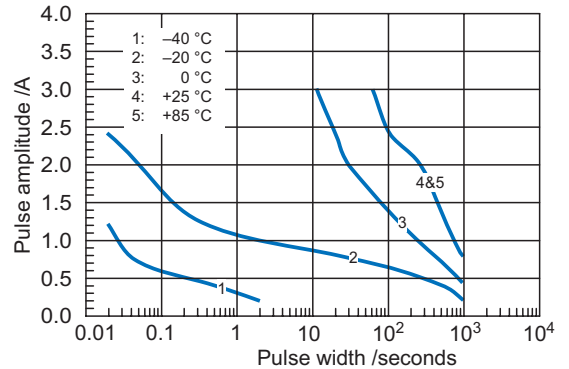

Pulse Voltage after 1 s

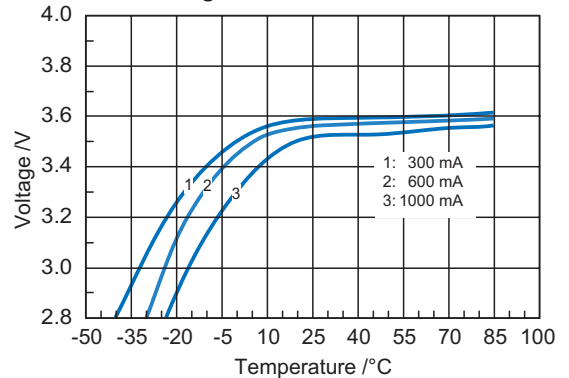

Available Capacity

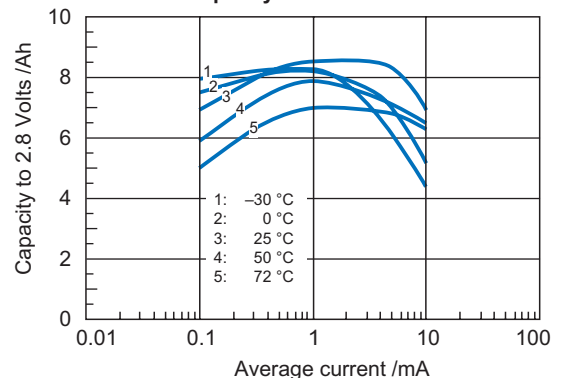

TLP-92111/A/SM

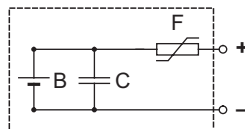
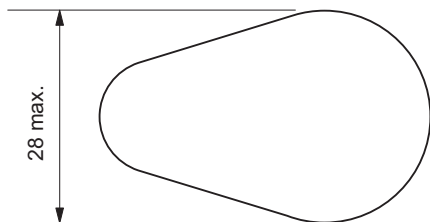
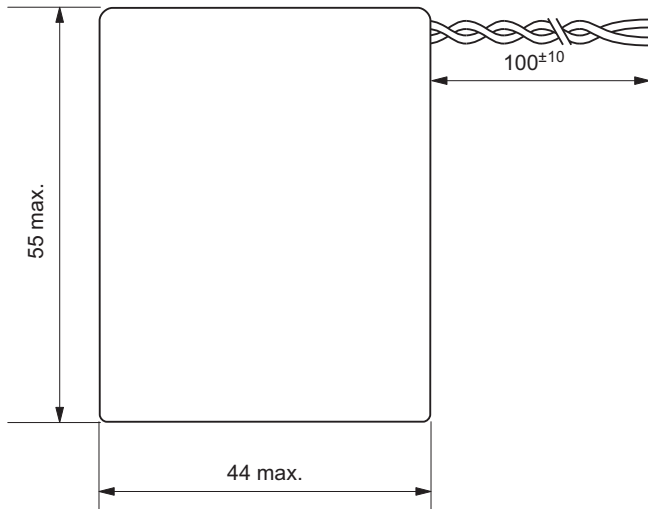

B = LTC battery
C = HLC
F = PTC (optional)

Both the LTC battery and the HLC are UL recognized.

Any values given here are for informational purpose only. They also depend on actual conditions of use and are not warranties of future performance. Subject to change.

Available Terminations

TLP-92111/A/SM Flying leads

Catalogue No.

14 1 5771 001



- ▶ High energy
- ▶ Up to 1 A pulse capability
- ▶ Instant voltage response
- ▶ No passivation effect

Type: TLP-92311/A

Performance Data

(Typical values for batteries stored at 25 °C for one year)

System	LTC and HLC
Nominal voltage	3.6 V
Nominal capacity	8.5 Ah
Nominal current	3 mA
Max. 1 s pulse to 3 V	1 A
Max. pulse length @ 0.125 A	1000 s
Delay time to 3 V @ 0.125 A	none
Weight	80 g
Temperature range	-40 °C ... +85 °C
Capacity retention after 10 yr	93 %

The battery is designed for applications where low background currents are combined with high current pulses. The **PulsesPlus** battery combines the inherent benefits of bobbin type Lithium Thionyl Chloride (LTC) batteries with a novel hermetically sealed hybrid Layer Capacitor (HLC). The LTC battery contributes high energy density while the HLC contributes high pulse current capability. The overall self discharge is thus minimized while safety is maximized.

Voltage during a Pulse at +25 °C

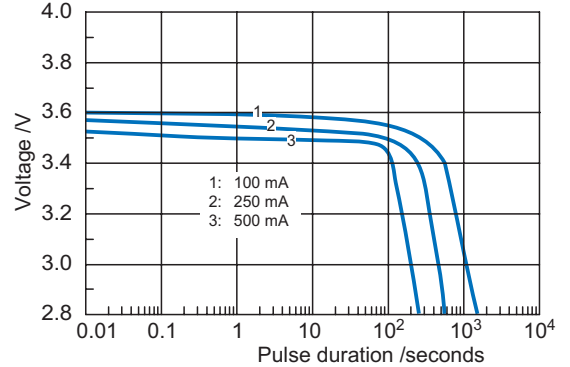

Maximum Pulse Width from 3.6 V to 2.8 V

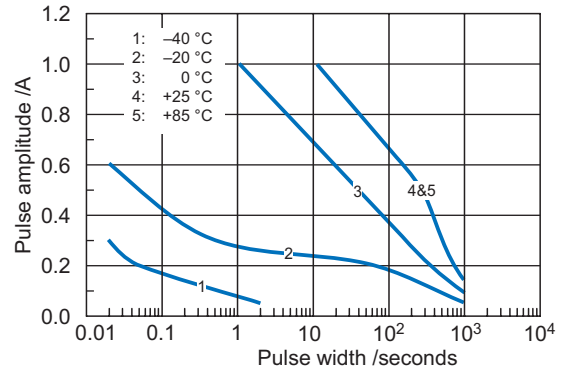

Pulse Voltage after 1 s

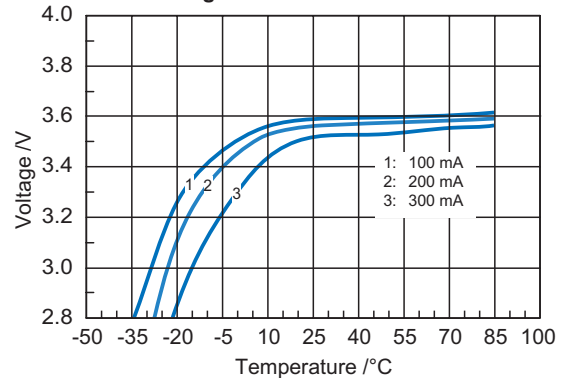

Available Capacity

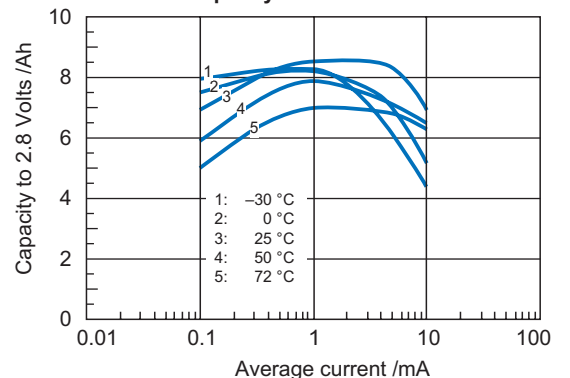

TLP-92311/A/SM

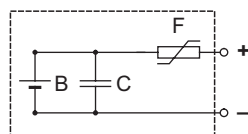
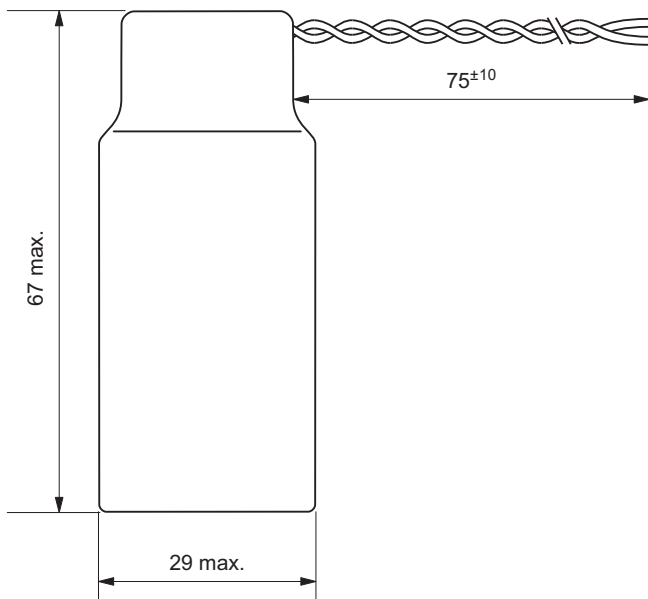

B = LTC battery
 C = HLC
 F = PTC (optional)

Both the LTC battery and the HLC are UL recognized.

Any values given here are for informational purpose only. They also depend on actual conditions of use and are not warranties of future performance. Subject to change.

Available Terminations

TLP-92311/A/SM Flying leads

Catalogue No.

14 1 5773 001

- ▶ High energy
- ▶ Up to 3 A pulse capability
- ▶ Instant voltage response
- ▶ No passivation effect



Type: TLP-93111/A

Performance Data

(Typical values for batteries stored at 25°C for one year)

System	LTC and HLC
Nominal voltage	3.6 V
Nominal capacity	19 Ah
Nominal current	6 mA
Max. 1 s pulse to 3 V	3 A
Max. pulse length @ 0.5 A	1000 s
Delay time to 3 V @ 0.5 A	none
Weight	140 g
Temperature range	-40°C ... +85°C
Capacity retention after 10 yr	96%

The battery is designed for applications where low background currents are combined with high current pulses. The **PulsesPlus** battery combines the inherent benefits of bobbin type Lithium Thionyl Chloride (LTC) batteries with a novel hermetically sealed hybrid Layer Capacitor (HLC). The LTC battery contributes high energy density while the HLC contributes high pulse current capability. The overall self discharge is thus minimized while safety is maximized.

Voltage during a Pulse at +25°C

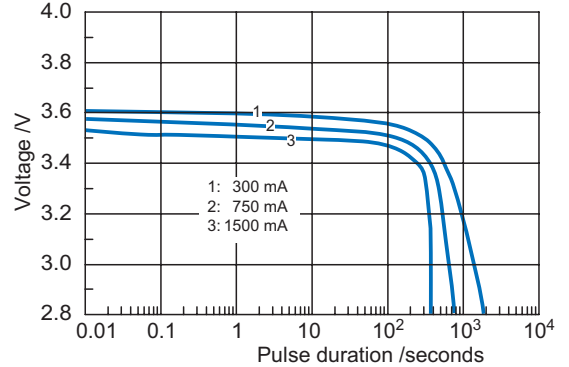

Maximum Pulse Width from 3.6 V to 2.8 V

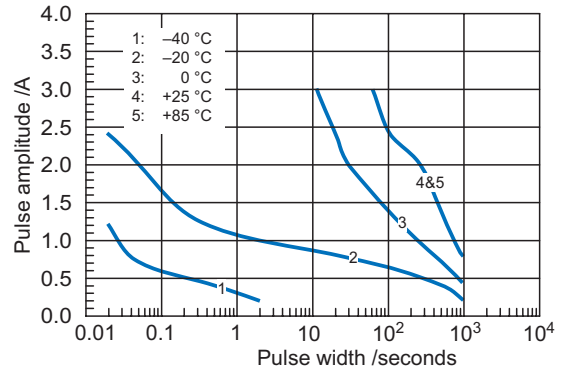

Pulse Voltage after 1 s

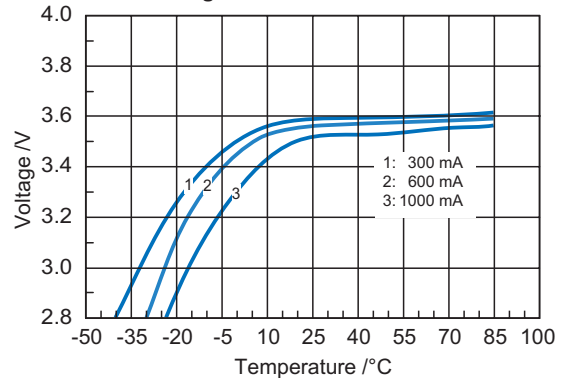

Available Capacity

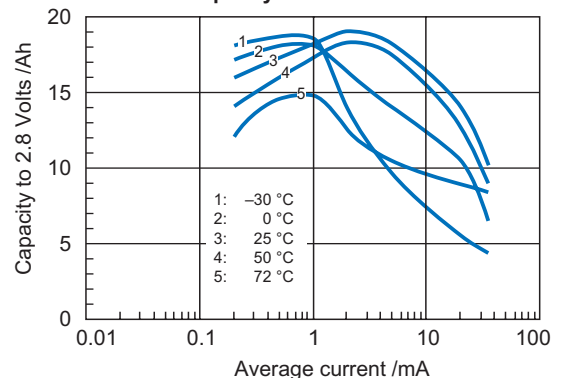

TLP-93111/A/SM

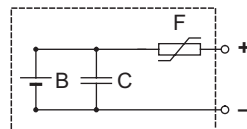
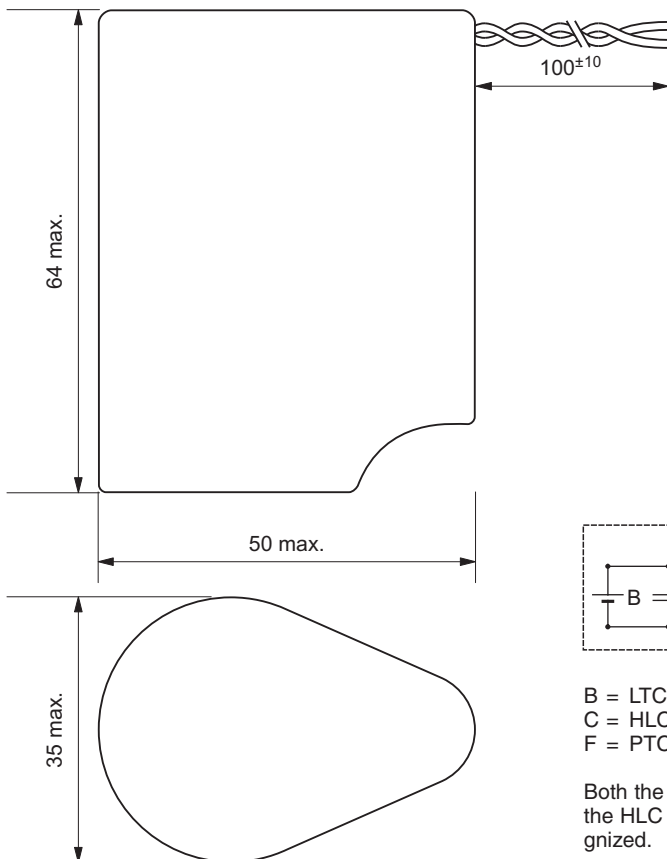

B = LTC battery
C = HLC
F = PTC (optional)

Both the LTC battery and the HLC are UL recognized.

Any values given here are for informational purpose only. They also depend on actual conditions of use and are not warranties of future performance. Subject to change.

Available Terminations

TLP-93111/A/SM Flying leads

Catalogue No.

14 1 5781 001

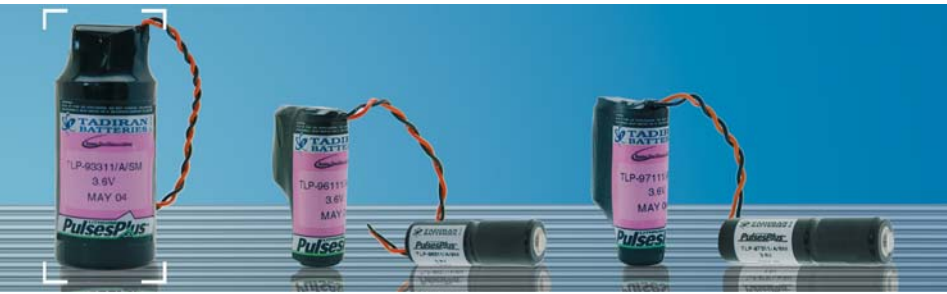

- ▶ High energy
- ▶ Up to 1 A pulse capability
- ▶ Instant voltage response
- ▶ No passivation effect

Type: TLP-93311/A

Performance Data

(Typical values for batteries stored at 25 °C for one year)

System	LTC and HLC
Nominal voltage	3.6 V
Nominal capacity	19 Ah
Nominal current	6 mA
Max. 1 s pulse to 3 V	1 A
Max. pulse length @ 0.125 A	1000 s
Delay time to 3 V @ 0.125 A	none
Weight	120 g
Temperature range	-40 °C ... +85 °C
Capacity retention after 10 yr	96 %

The battery is designed for applications where low background currents are combined with high current pulses. The **PulsesPlus** battery combines the inherent benefits of bobbin type Lithium Thionyl Chloride (LTC) batteries with a novel hermetically sealed hybrid Layer Capacitor (HLC). The LTC battery contributes high energy density while the HLC contributes high pulse current capability. The overall self discharge is thus minimized while safety is maximized.

Voltage during a Pulse at +25 °C

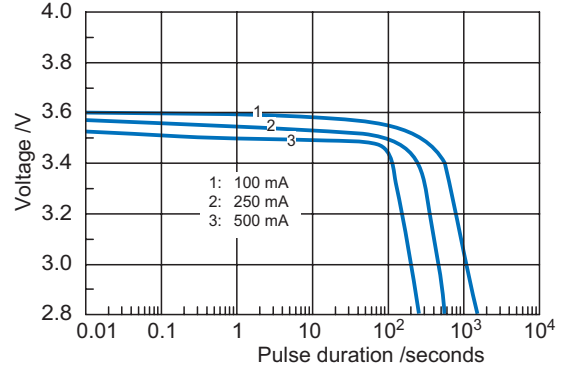

Maximum Pulse Width from 3.6 V to 2.8 V

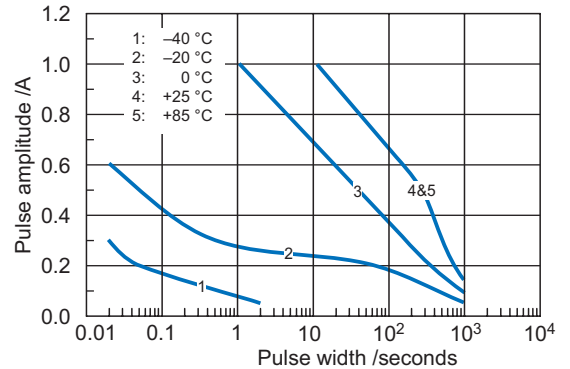

Pulse Voltage after 1 s

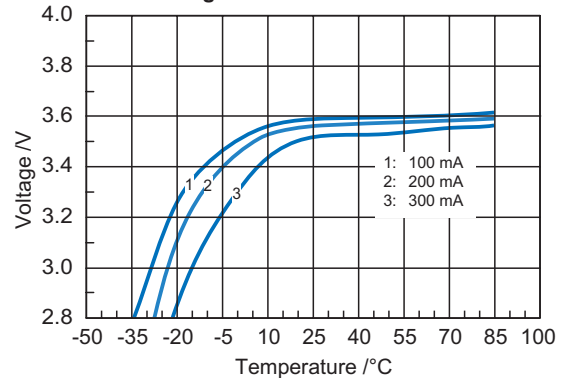

Available Capacity

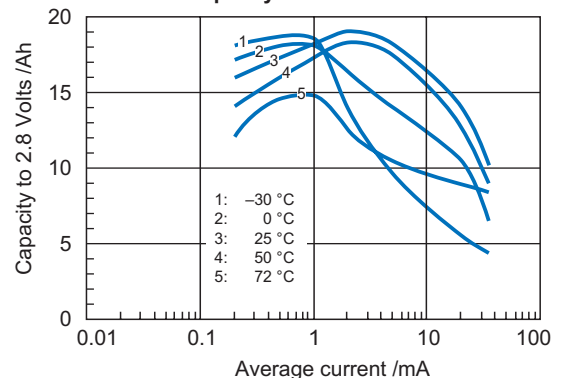

TLP-93311/A/SM

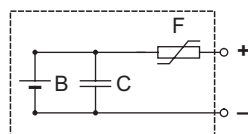
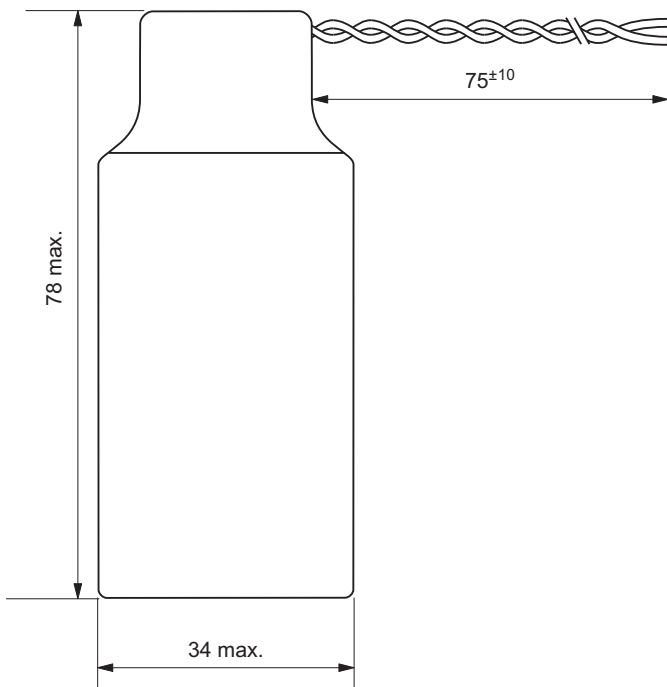

B = LTC battery
 C = HLC
 F = PTC (optional)

Both the LTC battery and the HLC are UL recognized.

Any values given here are for informational purpose only. They also depend on actual conditions of use and are not warranties of future performance. Subject to change.

Available Terminations

TLP-93311/A/SM Flying leads

Catalogue No.

14 1 5783 001

- ▶ High energy
- ▶ Up to 3 A pulse capability
- ▶ Instant voltage response
- ▶ No passivation effect



Type: TLP-96111/A

Performance Data

(Typical values for batteries stored at 25°C for one year)

System	LTC and HLC
Nominal voltage	3.6 V
Nominal capacity	1.2 Ah
Nominal current	0.6 mA
Max. 1 s pulse to 3 V	3 A
Max. pulse length @ 0.5 A	1000 s
Delay time to 3 V @ 0.5 A	none
Weight	45 g
Temperature range	-40°C ... +85°C
Capacity retention after 10 yr	78%

The battery is designed for applications where low background currents are combined with high current pulses. The **PulsesPlus** battery combines the inherent benefits of bobbin type Lithium Thionyl Chloride (LTC) batteries with a novel hermetically sealed hybrid Layer Capacitor (HLC). The LTC battery contributes high energy density while the HLC contributes high pulse current capability. The overall self discharge is thus minimized while safety is maximized.

Voltage during a Pulse at +25°C

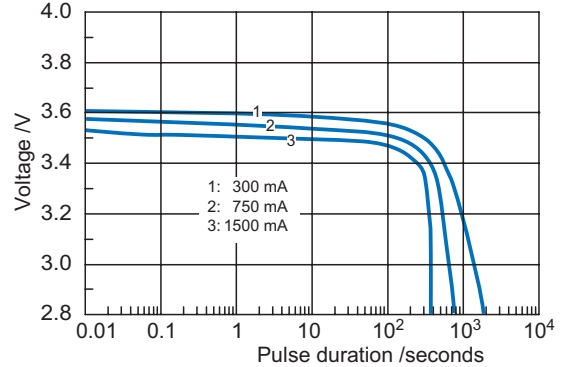

Maximum Pulse Width from 3.6 V to 2.8 V

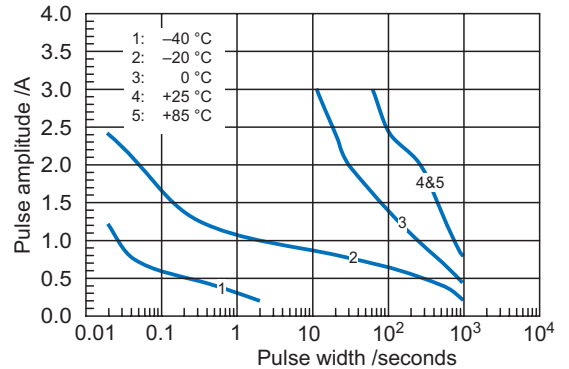

Pulse Voltage after 1 s

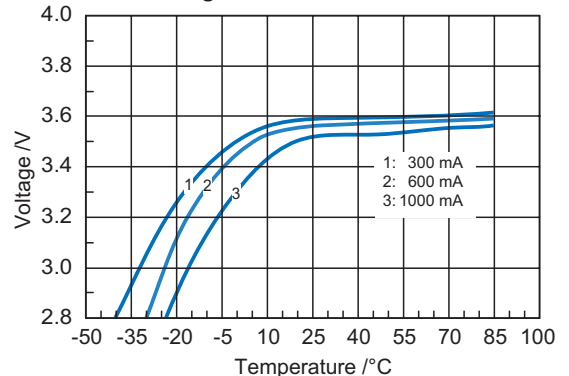

Available Capacity

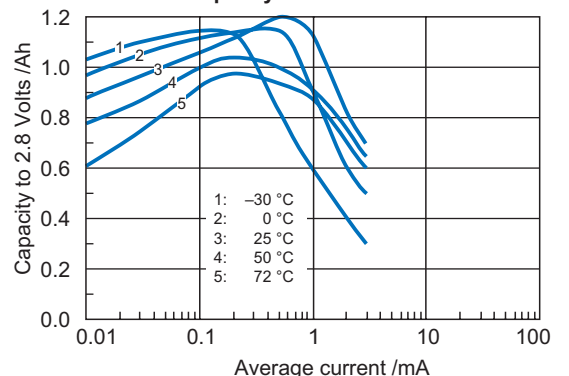

TLP-96111/A/SM

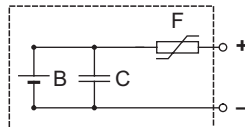
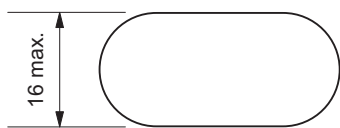
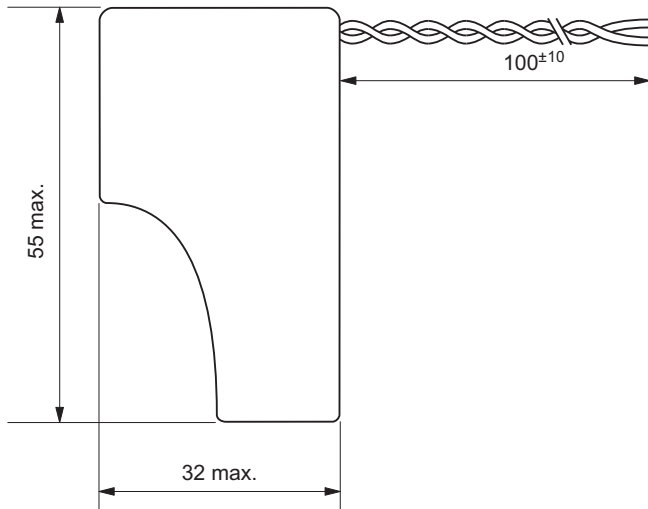

B = LTC battery
C = HLC
F = PTC (optional)

Both the LTC battery and the HLC are UL recognized.

Any values given here are for informational purpose only. They also depend on actual conditions of use and are not warranties of future performance. Subject to change.

Available Terminations

TLP-96111/A/SM Flying leads

Catalogue No.

14 1 5751 001



- ▶ High energy
- ▶ Up to 1 A pulse capability
- ▶ Instant voltage response
- ▶ No passivation effect

Type: TLP-96311/A

Performance Data

(Typical values for batteries stored at 25 °C for one year)

System	LTC and HLC
Nominal voltage	3.6 V
Nominal capacity	1.2 Ah
Nominal current	0.6 mA
Max. 1 s pulse to 3 V	1 A
Max. pulse length @ 0.125 A	1000 s
Delay time to 3 V @ 0.125 A	none
Weight	30 g
Temperature range	-40 °C ... +85 °C
Capacity retention after 10 yr	83 %

The battery is designed for applications where low background currents are combined with high current pulses. The **PulsesPlus** battery combines the inherent benefits of bobbin type Lithium Thionyl Chloride (LTC) batteries with a novel hermetically sealed hybrid Layer Capacitor (HLC). The LTC battery contributes high energy density while the HLC contributes high pulse current capability. The overall self discharge is thus minimized while safety is maximized.

Voltage during a Pulse at +25 °C

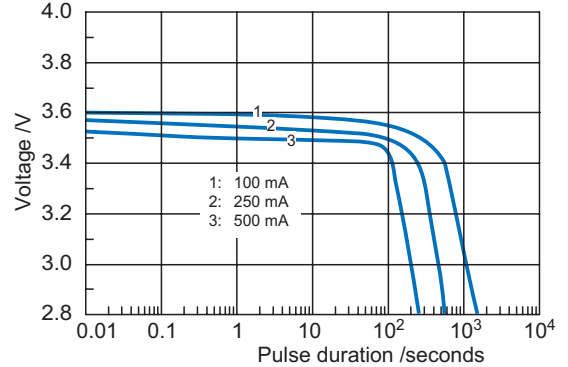

Maximum Pulse Width from 3.6 V to 2.8 V

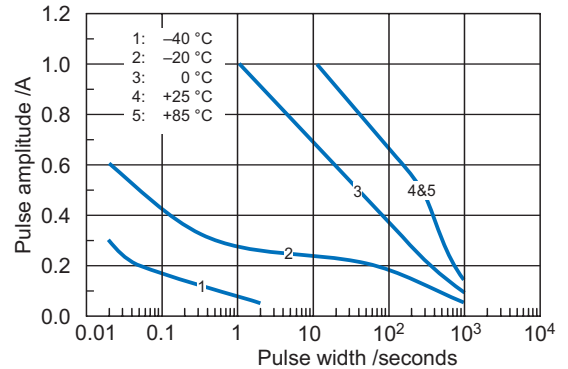

Pulse Voltage after 1 s

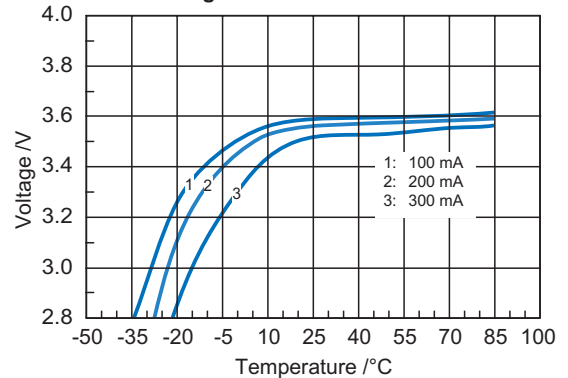

Available Capacity

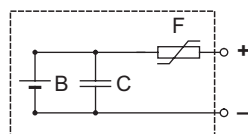
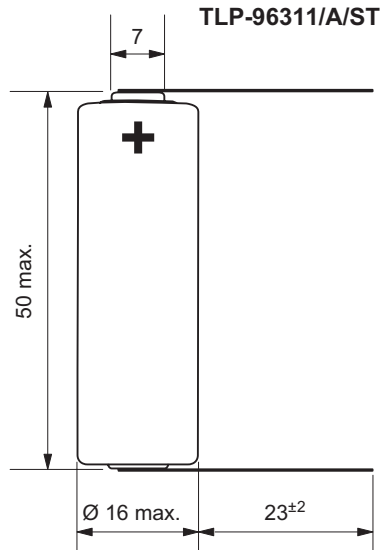
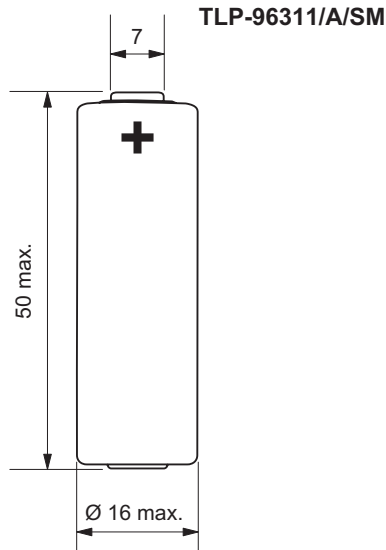
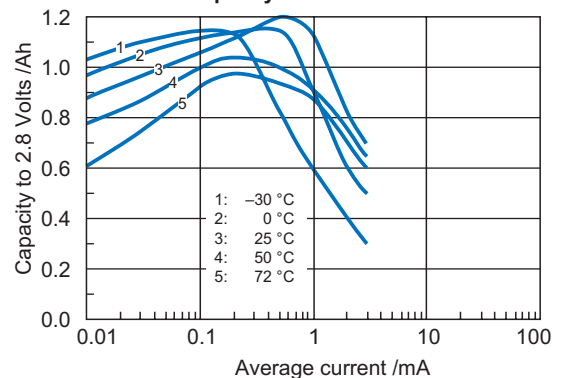

B = LTC battery
 C = HLC
 F = PTC (optional)

Both the LTC battery and the HLC are UL recognized.

Any values given here are for informational purpose only. They also depend on actual conditions of use and are not warranties of future performance. Subject to change.

Available Terminations

TLP-96311/A/SM	Pressure contacts	14 1 5753 001
TLP-96311/A/ST	Solder tags	14 1 5753 002

Catalogue No.

- ▶ High energy
- ▶ Up to 3 A pulse capability
- ▶ Instant voltage response
- ▶ No passivation effect



Type: TLP-97111/A

Performance Data

(Typical values for batteries stored at 25°C for one year)

System	LTC and HLC
Nominal voltage	3.6 V
Nominal capacity	1.65 Ah
Nominal current	1 mA
Max. 1 s pulse to 3 V	3 A
Max. pulse length @ 0.5 A	1000 s
Delay time to 3 V @ 0.5 A	none
Weight	45 g
Temperature range	-40°C ... +85°C
Capacity retention after 10 yr	80%

The battery is designed for applications where low background currents are combined with high current pulses. The **PulsesPlus** battery combines the inherent benefits of bobbin type Lithium Thionyl Chloride (LTC) batteries with a novel hermetically sealed hybrid Layer Capacitor (HLC). The LTC battery contributes high energy density while the HLC contributes high pulse current capability. The overall self discharge is thus minimized while safety is maximized.

Voltage during a Pulse at +25°C

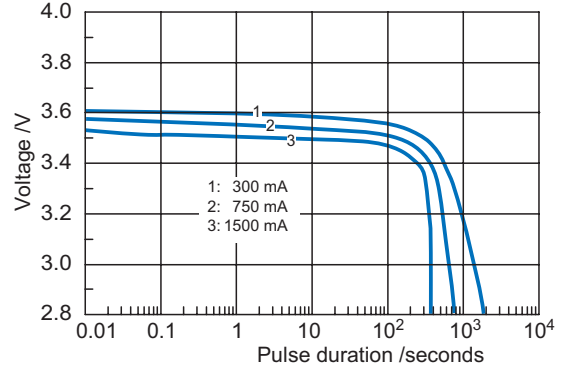

Maximum Pulse Width from 3.6 V to 2.8 V

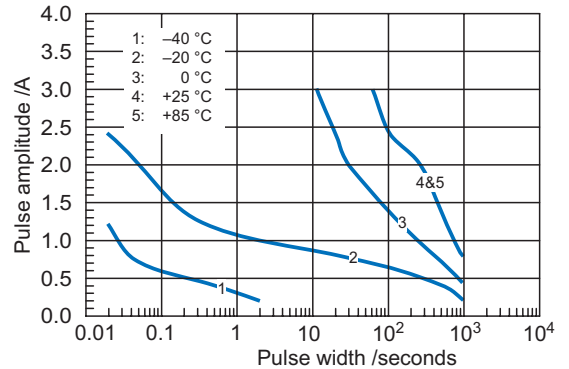

Pulse Voltage after 1 s

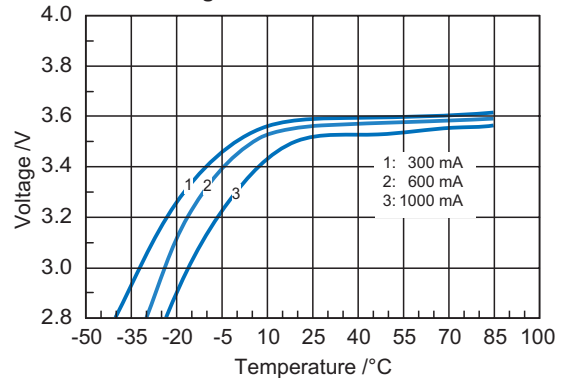

Available Capacity

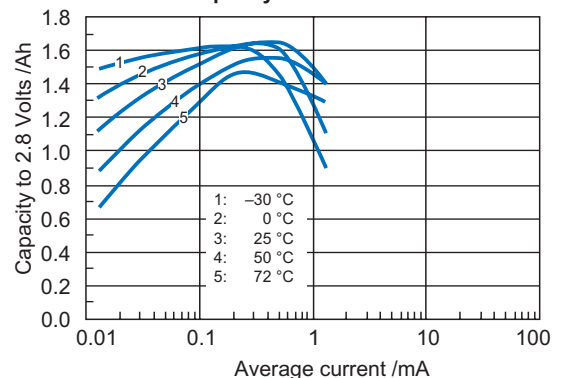

TLP-97111/A/SM

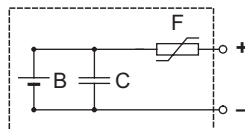
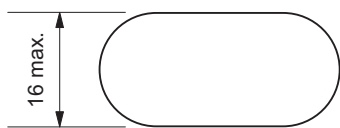
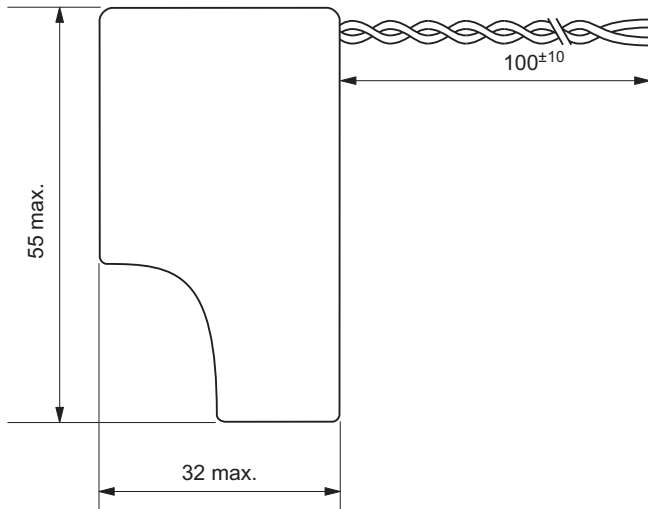

B = LTC battery
C = HLC
F = PTC (optional)

Both the LTC battery and the HLC are UL recognized.

Any values given here are for informational purpose only. They also depend on actual conditions of use and are not warranties of future performance. Subject to change.

Available Terminations

TLP-97111/A/SM Flying leads

Catalogue No.

14 1 5721 001



- ▶ High energy
- ▶ Up to 1 A pulse capability
- ▶ Instant voltage response
- ▶ No passivation effect

Type: TLP-97311/A

Performance Data

(Typical values for batteries stored at 25 °C for one year)

System	LTC and HLC
Nominal voltage	3.6 V
Nominal capacity	1.65 Ah
Nominal current	1 mA
Max. 1 s pulse to 3 V	1 A
Max. pulse length @ 0.125 A	1000 s
Delay time to 3 V @ 0.125 A	none
Weight	35 g
Temperature range	-40 °C ... +85 °C
Capacity retention after 10 yr	85 %

The battery is designed for applications where low background currents are combined with high current pulses. The **PulsesPlus** battery combines the inherent benefits of bobbin type Lithium Thionyl Chloride (LTC) batteries with a novel hermetically sealed hybrid Layer Capacitor (HLC). The LTC battery contributes high energy density while the HLC contributes high pulse current capability. The overall self discharge is thus minimized while safety is maximized.

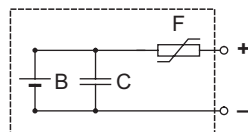
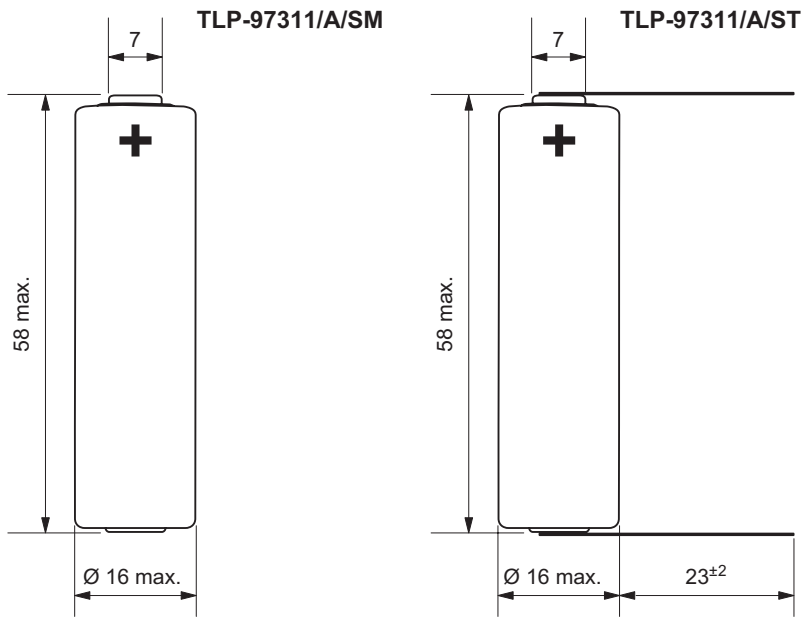

B = LTC battery
 C = HLC
 F = PTC (optional)

Both the LTC battery and the HLC are UL recognized.

Any values given here are for informational purpose only. They also depend on actual conditions of use and are not warranties of future performance. Subject to change.

Available Terminations

Catalogue No.

TLP-97311/A/SM	Pressure contacts	14 1 5723 001
TLP-97311/A/ST	Solder tags	14 1 5723 002

Voltage during a Pulse at +25°C

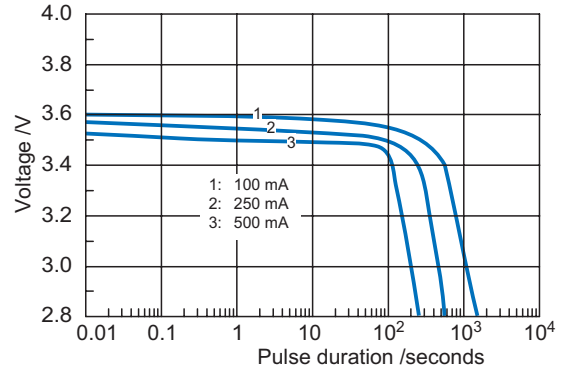

Maximum Pulse Width from 3.6 V to 2.8 V

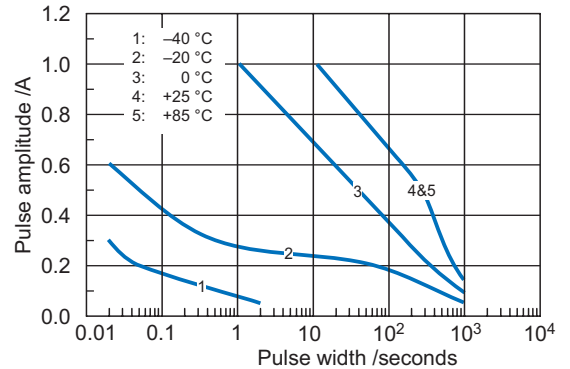

Pulse Voltage after 1 s

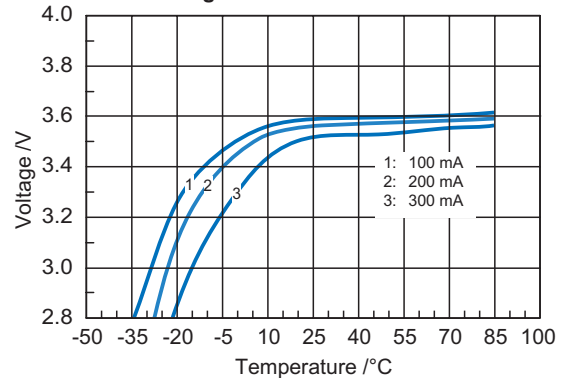

Available Capacity

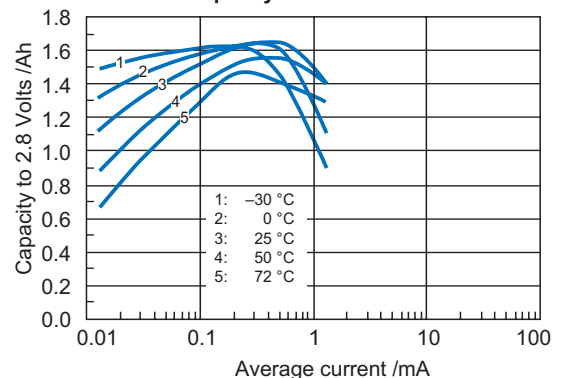

- ▶ Hybrid Layer Capacitor
- ▶ For use in **PulsesPlus** batteries

Type: HLC-1520

Performance Data

(Typical values in **PulsesPlus** batteries at 25°C)

System	Li-intercalated compounds
Nominal voltage	3.6 V, optional 3.9 V
Nominal capacity	140 As (39 mAh) @ 3.6 V 280 As (78 mAh) @ 3.9 V
Nominal current	50 mA
Max. cont. discharge current	500 mA
Pulse current capability	2000 mA
Max. charge voltage	3.95 V
Max. charge current	25 mA
Self discharge rate	1 µA @ 25°C; 5 µA @ 85°C
Cell impedance	≤ 250 mΩ
Weight	7.5 g

CAUTION:
Fire, explosion, and severe burn hazard. Do not crush, disassemble, heat above 100°C, or incinerate.

Use as part of **PulsesPlus™** battery only. Do not charge higher than 3.95 V.

See General Product Information for further safety recommendations

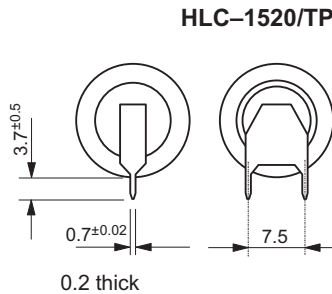
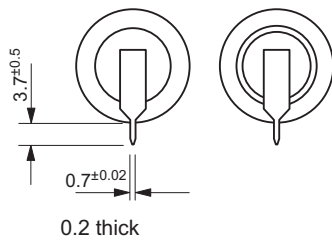
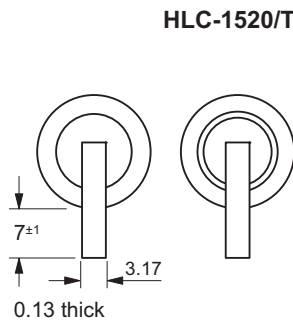
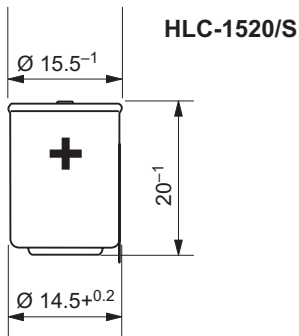

Available Terminations

HLC-1520/S	Standard
HLC-1520/T	Tags
HLC-1520/PT2	Pins radial
HLC-1520/TP	Polarized tags

Catalogue No.

11 5 10501 02
11 5 10502 02
11 5 10506 02
11 5 10508 02

Any values given here are for informational purpose only. They also depend on actual conditions of use and are not warranties of future performance. Subject to change.

Voltage during a Pulse at +25°C

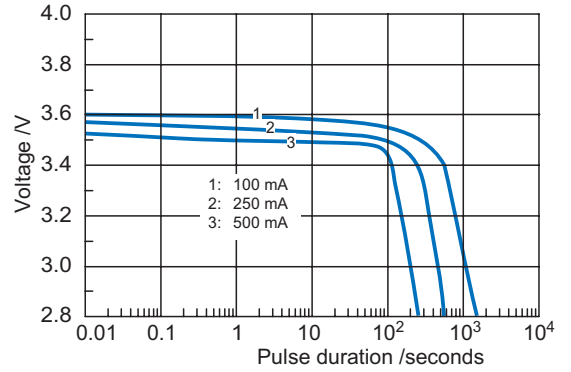

Maximum Pulse Width from 3.6 V to 2.8 V

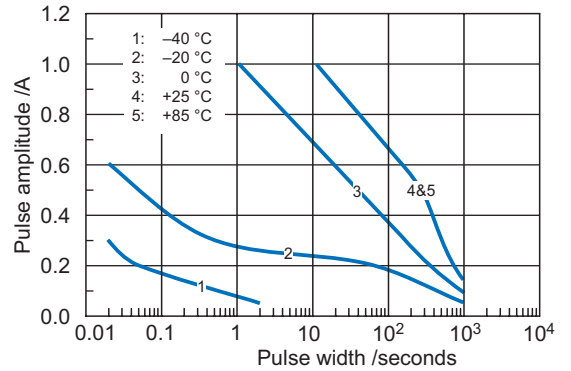

Pulse Voltage after 1 s

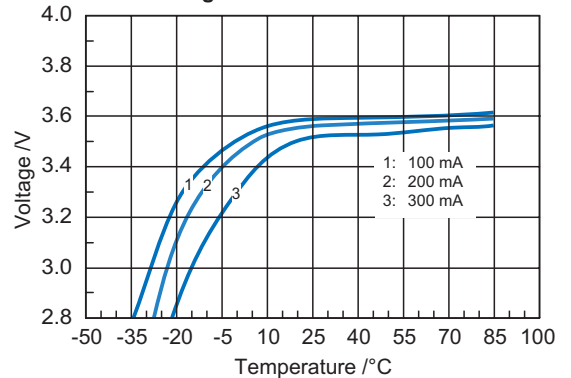

Capacity curve at +25°C, 50 mA

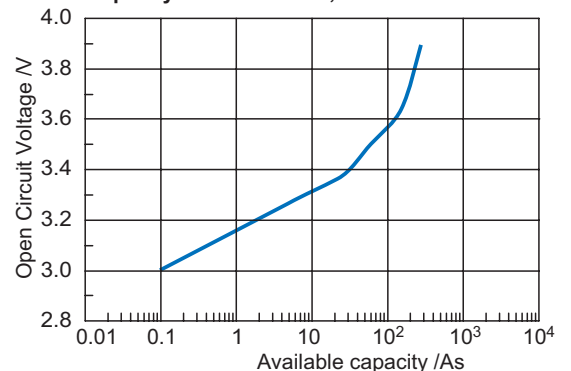

Type: HLC-1550

Performance Data

(Typical values in **PulsesPlus** batteries at 25 °C)

System	Li-intercalated compounds
Nominal voltage	3.6 V, optional 3.9 V
Nominal capacity	560 As (155 mAh) @ 3.6 V 1120 As (310 mAh) @ 3.9 V
Nominal current	50 mA
Max. cont. discharge current	2000 mA
Pulse current capability	5000 mA
Max. charge voltage	3.95 V
Max. charge current	100 mA
Self discharge rate	3 µA @ 25°C; 15 µA @ 85°C
Cell impedance	≤ 100 mΩ
Weight	20 g

CAUTION:
Fire, explosion, and severe burn hazard. Do not crush, disassemble, heat above 100 °C, or incinerate.

Use as part of **PulsesPlus™** battery only. Do not charge higher than 3.95 V.

See General Product Information for further safety recommendations

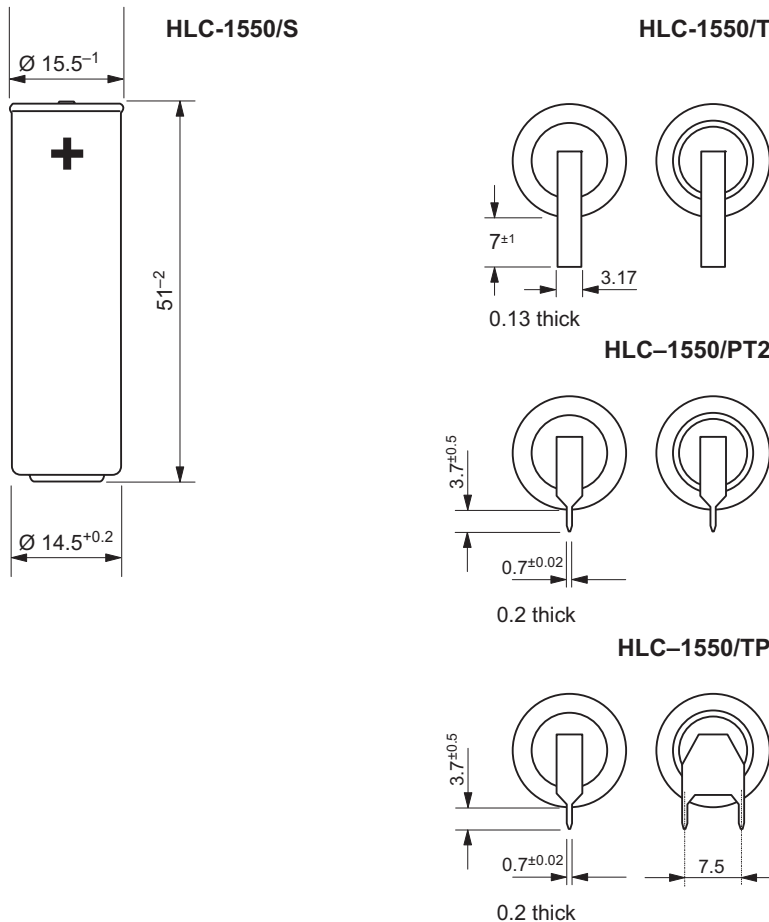

Available Terminations

HLC-1550/S	Standard
HLC-1550/T	Tags
HLC-1550/PT2	Pins radial
HLC-1550/TP	Polarized tags

Catalogue No.

11 5 10601 02
11 5 10602 02
11 5 10606 02
11 5 10608 02

Any values given here are for informational purpose only. They also depend on actual conditions of use and are not warranties of future performance. Subject to change.

- ▶ Hybrid Layer Capacitor
- ▶ For use in **PulsesPlus** batteries

Voltage during a Pulse at +25°C

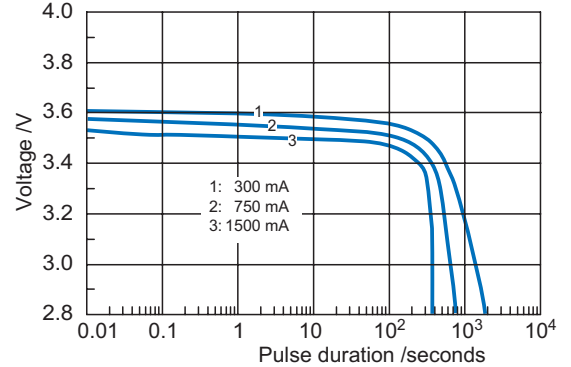

Maximum Pulse Width from 3.6 V to 2.8 V

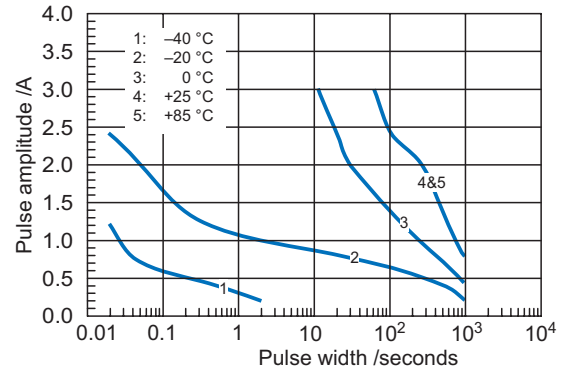

Pulse Voltage after 1 s

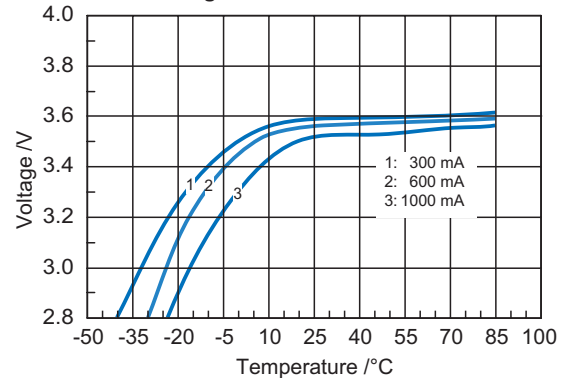

Capacity curve at +25°C, 50 mA

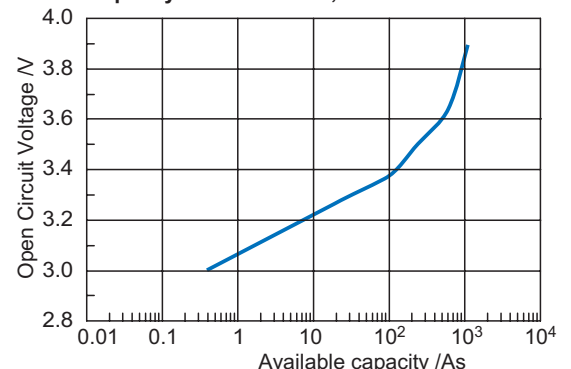

General Product Information

Product group: Hybrid Layer Capacitors (HLC)

General Hybrid Layer Capacitors are a kind of rechargeable battery. They are used as a capacitor in **PulsesPlus** batteries, where they are connected in parallel to Tadiran Lithium Batteries. The electrodes of HLC's comprise lithium intercalation compounds. They have low impedance and can deliver high current pulses. The performance and reliability properties of HLC's have been carefully optimized to match those of Tadiran Lithium Batteries. The result is a battery with a maximum of both energy and power density for stand alone use of up to ten years or more.

HLC's are normally charged to 3.6 V, optionally to 3.9 V.

Temperature range

–40 °C ... +85 °C for operation in **PulsesPlus** batteries
–30 °C ... +60 °C for independent storage and use

Electrical characteristics

Discharge end voltage 2.8 V Discharge below 2.5 V at 25 °C and discharge below 2 V at –40 °C may lead to an increase of the internal resistance.

Shelf life	in PulsesPlus batteries	used independently
@ 25 °C	10 years	1 year
@ 60 °C	7 years	4 weeks
@ 85 °C	≥ 1 year	1 week

Cycle life	at 3.6 V	at 3.9 V
to 1 % DOD	400 000 cycles	100 000 cycles
to 10 % DOD	40 000 cycles	10 000 cycles
to 100 % DOD	4 000 cycles	1 000 cycles

(DOD = depth of discharge)

Safety

WARNING HLC's are designed for use in **PulsesPlus** batteries. When used independently, they must not be fast charged.
Overcharge above 3.95 V may lead to capacity loss and/or an increase of internal resistance
Overcharge above 4.4 V may lead to excessive internal pressure. This may result in explosion or rupture.

UL recognition under file MH 12193

Transport

HLC's have passed the UN transport tests. They contain less than 1 g lithium equivalent and are not subject to dangerous goods regulations. They can be transported by air according to IATA DGR, special provision A45 and by rail/road/sea according to RID/ADR/IMDG code, special provision 188.

Any values given here are for informational purpose only. They also depend on actual conditions of use and are not warranties of future performance. Subject to change.

Product list and features

Model	Termination	Catalogue number	Configuration Primary cell	HLC	Nominal voltage	Nominal capacity	Maximum 1 s pulse to 3 V	Dimensions mm	Weight	Page
TLP-91111/A/SM	Flying leads	14 1 5761 001	AA	1550	3.6 V	2.40 Ah	3 A	55 × 32 × 16	55 g	2
TLP-91311/A/SM TLP-91311/A/ST	Pressure contacts Solder tags	14 1 5763 001 14 1 5763 002	AA	1520	3.6 V	2.40 Ah	1 A	∅ 16 × 75	40 g	3
TLP-92111/A/SM	Flying leads	14 1 5771 001	C	1550	3.6 V	8.50 Ah	3 A	55 × 44 × 28	100 g	4
TLP-92311/A/SM	Flying leads	14 1 5773 001	C	1520	3.6 V	8.50 Ah	1 A	∅ 29 × 67	80 g	5
TLP-93111/A/SM	Flying leads	14 1 5781 001	D	1550	3.6 V	19.00 Ah	3 A	64 × 50 × 35	140 g	6
TLP-93311/A/SM	Flying leads	14 1 5783 001	D	1520	3.6 V	19.00 Ah	1 A	∅ 34 × 78	120 g	7
TLP-96111/A/SM	Flying leads	14 1 5751 001	½AA	1550	3.6 V	1.20 Ah	3 A	55 × 32 × 16	45 g	8
TLP-96311/A/SM TLP-96311/A/ST	Pressure contacts Solder tags	14 1 5753 001 14 1 5753 002	½AA	1520	3.6 V	1.20 Ah	1 A	∅ 16 × 50	30 g	9
TLP-97111/A/SM	Flying leads	14 1 5721 001	¾AA	1550	3.6 V	1.65 Ah	3 A	55 × 32 × 16	45 g	10
TLP-97311/A/SM TLP-97311/A/ST	Pressure contacts Solder tags	14 1 5723 001 14 1 5723 002	¾AA	1520	3.6 V	1.65 Ah	1 A	∅ 16 × 58	35 g	11
HLC-1520/S HLC-1520/T HLC-1520/PT2 HLC-1520/TP	Standard Tags Pins radial Polarized tags	11 5 10501 02 11 5 10502 02 11 5 10506 02 11 5 10508 02		1520	3.6 V	140 As	1 A	∅ 15.5 × 20	7.5 g	12
HLC-1550/S HLC-1550/T HLC-1550/PT2 HLC-1550/TP	Standard Tags Pins radial Polarized tags	11 5 10601 02 11 5 10602 02 11 5 10606 02 11 5 10608 02		1550	3.6 V	560 As	3 A	∅ 15.5 × 50	20 g	13

High energy batteries for high current pulses

PulsesPlus batteries are available in a wide variety of configurations (cylindrical and prismatic battery packs). ***PulsesPlus*** batteries feature a primary bobbin type cell and a unique hermetically sealed hybrid layer capacitor, which offers outstanding performance advantages, including:

- ▶ High and stable voltage 3.6 V (optional 3.9 V)
- ▶ High pulse current capability
- ▶ No passivation effect
- ▶ More capacity (up to 19 Ah per D size cell)
- ▶ Wide operating temperature range (-40 °C to + 85 °C)
- ▶ High reliability (hermetic laser sealing, glass-to-metal seal)
- ▶ Outstanding storage capability (up to 10 years)
- ▶ Recognized safety (UL)
- ▶ Very low self discharge (less than 2% per year)

- ▶ extend replacement intervals
- ▶ withstand rough environments
- ▶ are safer than other lithium batteries

PulsesPlus Batteries are ideal for applications requiring long life and high energy under high current pulse requirements.

These applications include:

- ▶ Automotive emergency systems
- ▶ Traffic telematics
- ▶ GPS tracking devices
- ▶ GSM modems
- ▶ Tank level monitoring
- ▶ Pipe line monitoring
- ▶ Oceanographic devices
- ▶ RFID transponders
- ▶ Automatic meter reading
- ▶ Data loggers
- ▶ Security devices
- ▶ Emergency equipment
- ▶ Wireless sensors
- ▶ Defibrillators and
- ▶ Other medical devices.

